

# Encore Presentation System

## Quick Start Guide

**Barco Media and Entertainment**  
11101 Trade Center Drive  
Rancho Cordova, CA  
95670 • USA

Phone: +1 (916) 859-2500  
Fax: +1 (916) 859-2515  
Technical Support: +1 (866) 374-7878  
Website: www.barco.com

### Encore Controller — Rear Panel: Models SC and LC

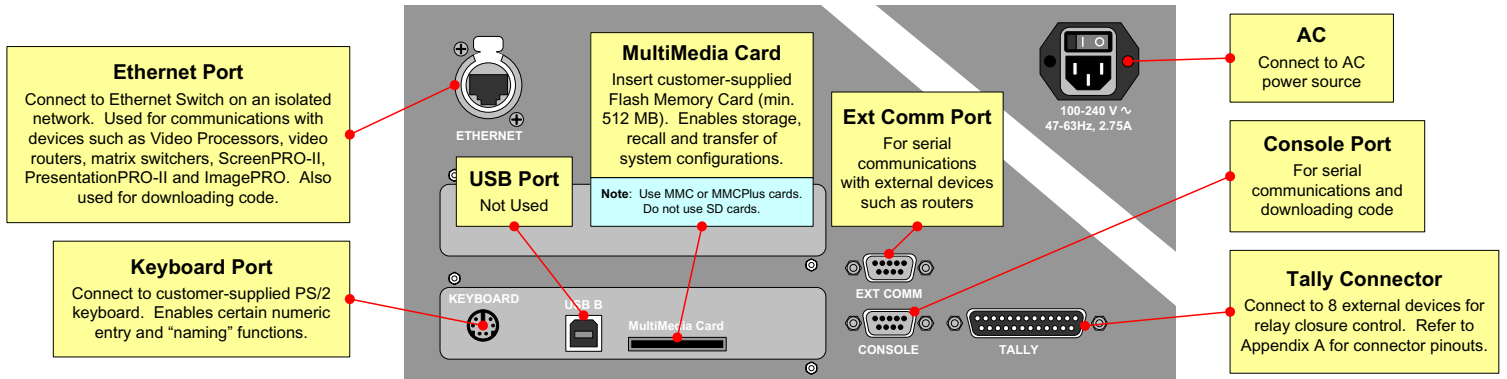

### System Setup



System setup is comprised of 20 sequences, each of which includes many steps. For error-free installation, always refer to the associated section in Chapter 6 of the User's Guide. The circled sequence numbers are identical.

Before you begin, ensure that your system is properly cabled. Use the sample "configuration" charts in Chapter 3 of the User's Guide.

- 1 **ID Setup and Remote Enable** — Set up individual Video Processor, ScreenPRO-II, PrePRO-II and ImagePRO IDs. Enable remote control on all units.
- 2 **Peripheral Power Up, Status Check** — Power up routers and peripherals. Use **Status Menu** to check code compatibility. Download code (if required).
- 3 **Return to Factory Default** — Perform a complete factory reset on all devices. This procedure resets all router tables and source mappings.
- 4 **Touch Screen Calibration** — Calibrate the Controller's Touch Screen display(s).
- 5 **Programming EDID** — For your background and DSK sources, program EDID to ensure proper communications to your PCs at the preferred resolution.
- 6 **Restore from Flash Memory Card** — If you backed up to Flash Memory, restore the configuration at this point. No further setup steps are necessary.
- 7 **Router Setup** — Set up your system's routing switcher(s), including type, communications, output patching, and designating Aux outputs.
- 8 **D/A Setup** — Set up your system's Distribution Amplifiers, including type, number of outputs, and output patching.
- 9 **Input Patching** — Associate (patch) specific router inputs to specific source buttons on the Controller. Assign tally connections as desired.
- 10 **Destination Setup** — Set up single screen, wide screen, stack and ScreenPRO-II destinations. Note that "stacking" is only available with the Controller LC.
- 11 **Aux Destination Setup** — Set up your system's Auxiliary destinations, including Aux, ImagePRO Aux and PresentationPRO-II Aux destinations as required.
- 12 **Output Format Setup** — Configure the output format for each Video Processor and ScreenPRO-II. Always match the native resolution of the display or projector.

- 13 **Sync Setup** — Set up sync parameters for the monitors and projectors connected to the system.
- 14 **Genlock Setup** — Set up Genlock for each destination selected on the **Output Menu**.
- 15 **Projector Setup** — Set up your projectors for both single screen and wide screen destinations.
- 16 **Background Setup** — Set up the Controller's two background sources for all single, wide screen, stack and ScreenPRO-II destinations.
- 17 **Input Setup** — Set up your system's inputs for single, wide screen, stack and ScreenPRO-II destinations. Both "quick" and "detailed" methods are outlined.
- 18 **DSK Setup** — Set up the Controller's DSK source. Choose between "none," DVI, analog or a captured frame grab.
- 19 **Save the Setup** — On the **System Keypad**, press **SAVE** to save the state of the Controller in non-volatile memory.
- 20 **Backup to Flash Memory Card** — Back up your system configuration to a customer-supplied Flash Memory Card.

P/N 26-0313003-00, Rev A

## Encore Controller — Front Panels

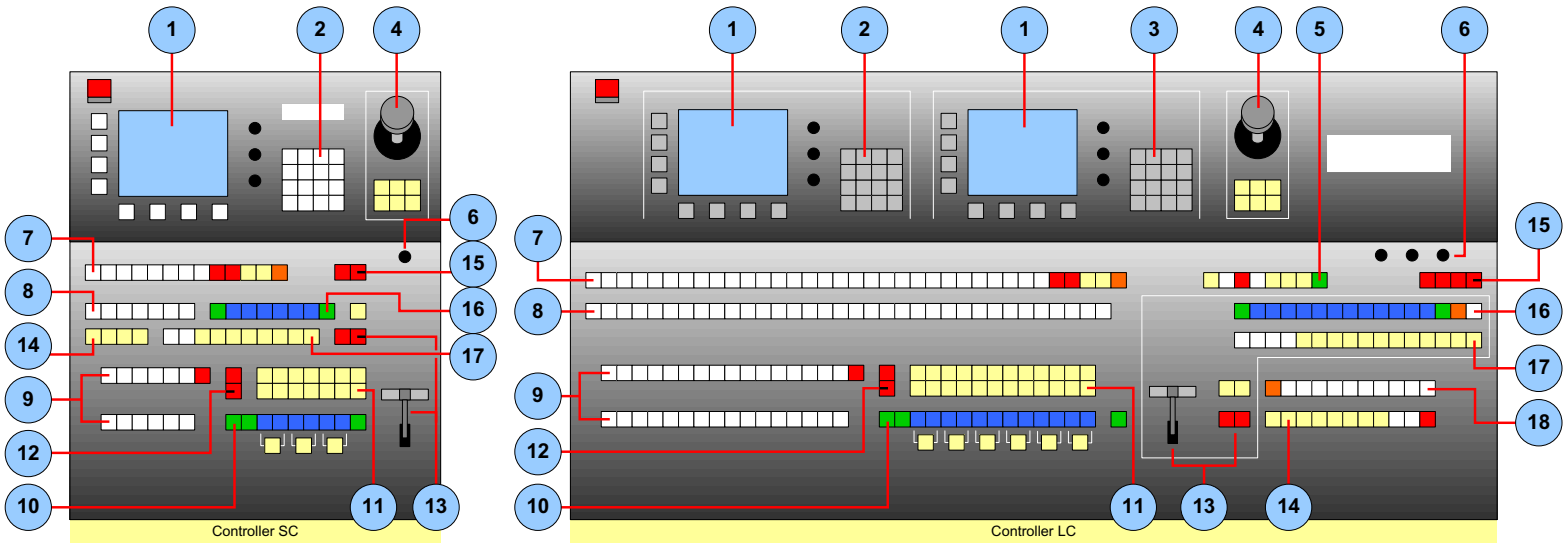

<b>1 Touch Screen Section</b>	Used for system configuration, setup and operational adjustments, such as PIPs and Keys.	<b>10 Layer Control Section</b>	Buttons select the layer(s) that will transition to or from Program. <b>Split</b> buttons control the "mode" of each mixer.
<b>2 System Keypad</b>	Provides direct access to all system configuration, setup and status menus.	<b>11 Layer Functions Section</b>	Buttons in this section apply to the active (blinking) layer, enabling you to change the layer's mode and attributes.
<b>3 Alphanumeric Keypad</b>	<b>(Controller LC only)</b> Enables you to enter and change numeric values on the Touch Screen.	<b>12 Live Switch Section</b>	The two <b>Live Switch</b> buttons change the function of the Source Selection Bus, enabling you to take sources "live" to Program.
<b>4 Joystick Section</b>	Joystick enables you to adjust PIPs, Keys and other parameters. Dedicated buttons allow you to change the Joystick's function.	<b>13 Transition Section</b>	Includes the T-Bar for manually mixing sources, plus dedicated buttons for cuts and auto-transitions.
<b>5 Machine Control Section</b>	<b>(Controller LC only)</b> Not implemented.	<b>14 Group Control Section</b>	To simplify destination selection process, each "Group" button can be programmed to activate one or more destinations.
<b>6 Console Lighting</b>	Knobs control the brightness of the low-voltage "script" lights.	<b>15 Program Preset Section</b>	Not implemented.
<b>7 Preset Section</b>	Buttons enable you to store and recall Controller setups. Each button represents a single "look" of the overall projected image.	<b>16 Layer/Aux Control</b>	Not implemented.
<b>8 Destination Bus</b>	Each button selects an active destination (e.g., single screen, wide screen, aux) to which you can route the Controller's output.	<b>17 Transition Functions</b>	Buttons set parameters for the current transition and mode, such as mix source, toggle, swap, move and black preview.
<b>9 Source Selection Bus</b>	Each button represents a source that you can route to PIPs, Keys and Aux destinations.	<b>18 User Key Section</b>	<b>(Controller LC only)</b> Each button stores PIP and Key parameters, enabling you to copy between layers and mixers.

### 1 Touch Screen Section

Four ways to access a function or a menu:

- 1) Touch a button on the Touch Screen
- 2) Press the **Softkey** adjacent to a label
- 3) Use **NAV** to move the highlight, then **ADJ**
- 4) Touch a line to move highlight, then **ADJ**

**NAV**  
Move highlight up and down, or adjust the labeled parameter

**ADJ**  
Adjust the highlighted parameter

**Softkeys**  
Softkey labels (when present) appear on the Touch Screen

### 2 System Keypad

- Selects the **Output Menu**
- Selects the **Input Menu**
- Selects the **Presets Menu**
- Selects the **Effects Menu**
- Selects the **Status Menu**
- Selects the **System Menu**
- Selects the **Miscellaneous Menu**
- Selects the **User Key Copy Setup Menu**
- Saves the state of the Controller

■ Controller LC only  
■ Not Implemented

### 3 Alphanumeric Keypad (Controller LC only)

**Active Menus**

**No restrictions:**

- Key Menu
- Border Menu
- Shadow Menu
- Effects Menu

**Select Status Menu first:**

- Input Menu
- Sizing Menu(s)
- Color Balance Menu

**Turn desired rotary knob first to activate a field:**

- PIP Adjustment Menu
- Input Source Adjustment Menu
- Key Adjustment Menu
- Key Source Adjustment Menu

**To enter a value:**

1. Highlight (or select) the desired field.
2. Enter the desired value on the keypad.
3. Press **Enter** to accept.

**Note:**

- Press **Clear** to delete last number entered.
- For negative values, press **Clear** before entering first number.

■ Not Implemented

### 4 Joystick Section

- Crop boundaries of PIP or Key
- Zoom source within PIP or Key
- Crop top and left edges
- Reset the current effect to default
- Increase precision of Joystick
- Crop bottom and right edges

Adjust the selected PIP or Key. **X-Axis** (left/right), **Y-Axis** (up/down), **Z-Axis** (size). **Z-Axis** also adjusts value of highlighted parameter on Touch Screen.

### 5 Machine Control Section (Controller LC only)

**MACHINE CONTROL**

Rev Jog      Fwd Jog

Still   Rev   Stop   Fast Fwd   Mark In   Mark Out   Cue Load   Play/Gang/Roll

■ All buttons in the Machine Control Section are not implemented

### 6 Console Lighting

- Controls brightness of left, center and right-hand "script" lights
- Controls "script" light brightness

Left      Center      Right      Light

Controller LC      Controller SC



### 12 Live Switch Section

**Shift + Source** activates **Live Switch Source** mode, which turns both rows of the Source Selection Bus into a live Program bus.

**Shift + Program/Preview** activates **Live Switch Program/Preview** mode, which turns both rows of the Source Selection Bus into a live Program/Preview bus. Top row = **Program**, bottom row = **Preview**.

Not Implemented

### 13 Transition Section

**T-Bar**  
Manually transition sources to/from Program, based on current transition type.

Instantly cut layers from Preview to Program

Transition automatically from Preview to Program. Use **Effects Menu** to set all transition parameters.

Not Implemented

### 14 Group Control Section

**Controller SC:** 4 Groups  
**Controller LC:** 8 Groups

Program Group buttons to represent one or more destinations

Activate desired destination(s), then hold and press **Group #** to learn.

Alternate "learn" method (both Controllers): Hold **Group #**, toggle desired **Destination #s**

Press one (or more) group buttons to enable the assigned destination(s) and toggle all other groups off.

Activates all assigned groups

Hold and press **Group #** to clear one Group. **Clear + All** to clear all.

Controller LC only

### 15 Program Preset Section

**Controller LC**  
Program Preset 1, Program Preset 2, Program Preset 3, Presets To Program

**Controller SC**  
Program Preset 1, Presets To Program

All buttons in the Program Preset Section are not implemented

### 16 Layer/Aux Control Section

**LAYER / AUX CONTROL**  
BG, 1 A, 1 B, 2 A, 2 B, 3 A, 3 B, BSK, AUX, ALL

All buttons in the Layer / Aux Control Section are not implemented

### 17 Transition Functions Section

Co-locates both PIPs (**Split** is Off). If lit and PIP (in Preview) is not co-located, press to co-locate

Independently locate PIPs (**Split** is Off)

Re-start timeline on **Barco Events Manager**

Toggle sources with each transition

Pend "Move" on the active layer

Transitions final output to black. Layers are not affected

Not Implemented

### 18 User Key Section (Controller LC only)

100 User Keys provided (10 pages of 10 User Keys each)

Each button stores all (or a portion) of PIP or Key attributes, including the PIP or Key selection

Use the **User Key Copy Setup Menu** to select attributes

Hold and press **User Key #** to select page

Press and hold **User Copy**, then press **User Key #** to store active layer's attributes

Press **User Key #** to apply stored attributes to active layer

## Encore Video Processor (VP) — Rear Panel

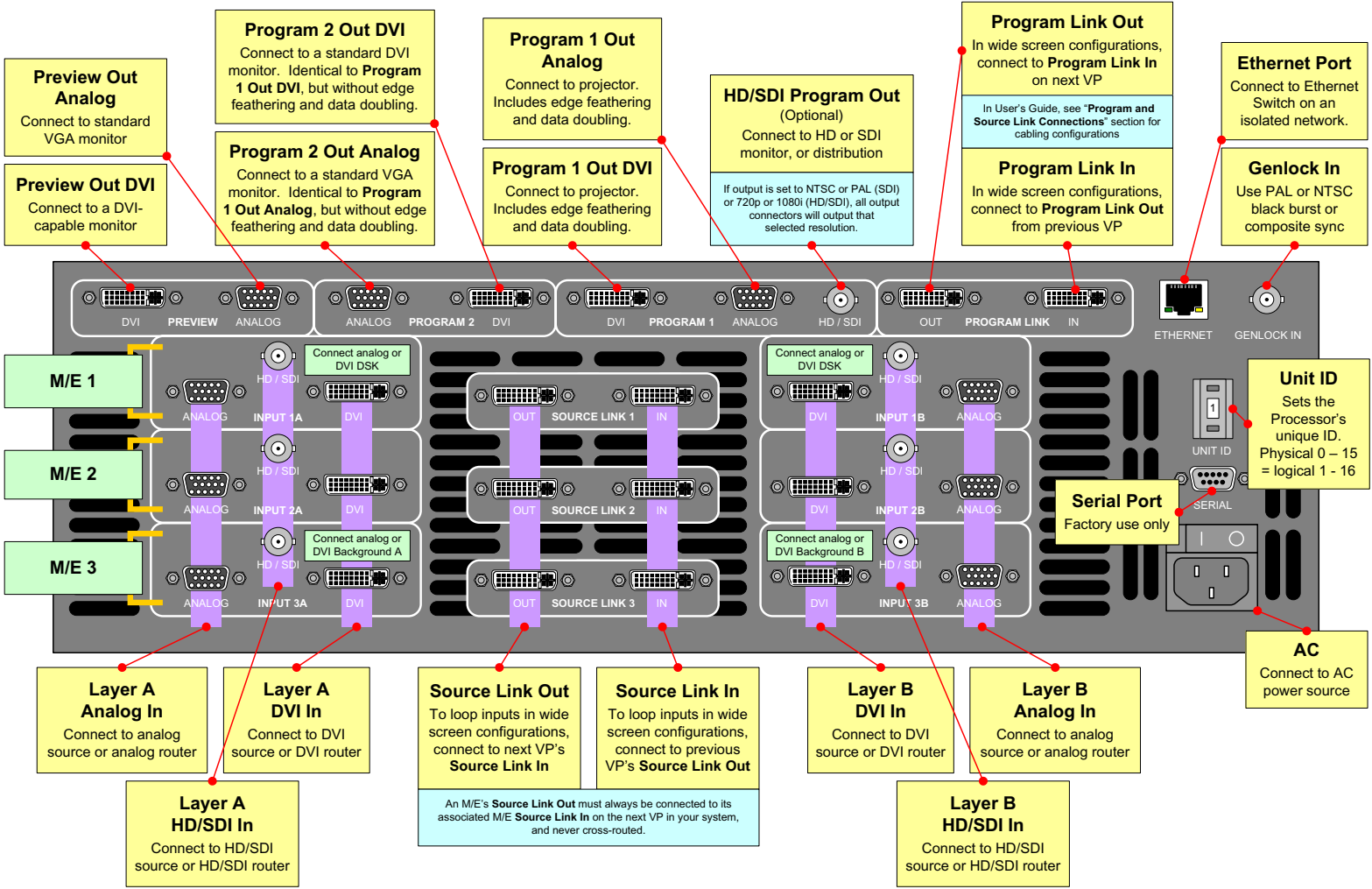

**3 M/E System:** **M/E 1** (highest priority layer, DSK connections, uses Mixer 3 on Controller), **M/E 2** (mid priority, Mixer 2 on Controller), **M/E 3** (lowest priority, Background connections, Mixer 1 on Controller).

**2 M/E System:** **M/E 1** (highest priority layer, DSK connections, uses Mixer 2 on Controller), **M/E 2** (lowest priority layer, Background connections, Mixer 1 on Controller), **M/E 3** (not installed).

**1 M/E System:** **M/E 1** (Use Layer A [DVI or Analog] for Background connections, use Layer B [DVI or Analog] for DSK connections), **M/E 2** (not installed), **M/E 3** (not installed).

### Sample System — Single Screen Configuration

- Non-stack system, up to 6 layers
- 1 x 3 M/E Video Processor
- 1 x SDI Router
- 1 x RGBHV Router
- 5 destinations:
  - 1) Projector
  - 2, 3) Aux Monitors
  - 4) ImagePRO Aux
  - 5) PresentationPRO-II Aux

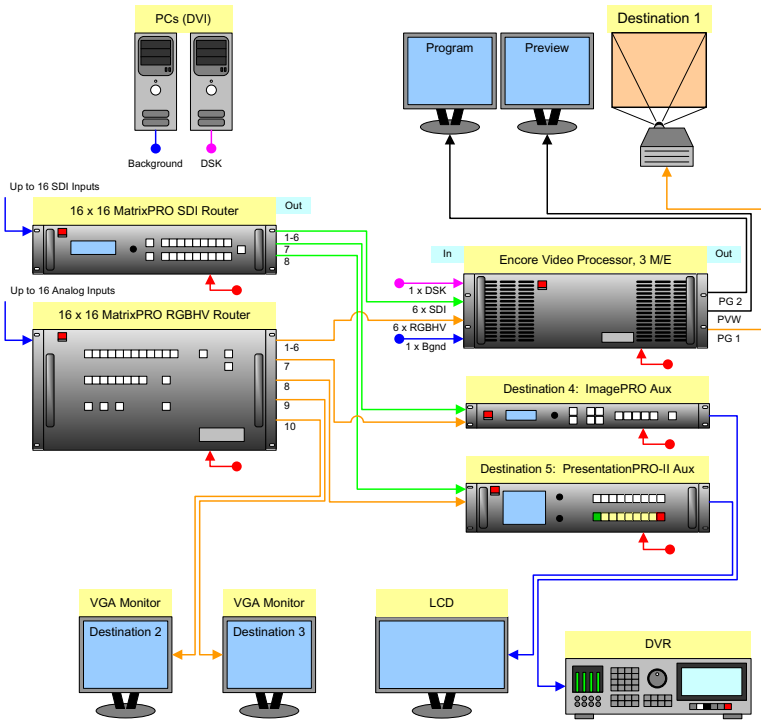
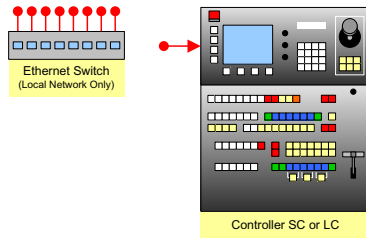

### Sample System — Multi Screen Configuration

- Non-stack system, up to 6 layers
- 2 x 3 M/E Video Processors
- 1 x SDI Router
- 1 x RGBHV Router
- 5 destinations:
  - 1, 2) Projectors
  - 3) ScreenPRO-II
  - 4, 5) Aux Monitors

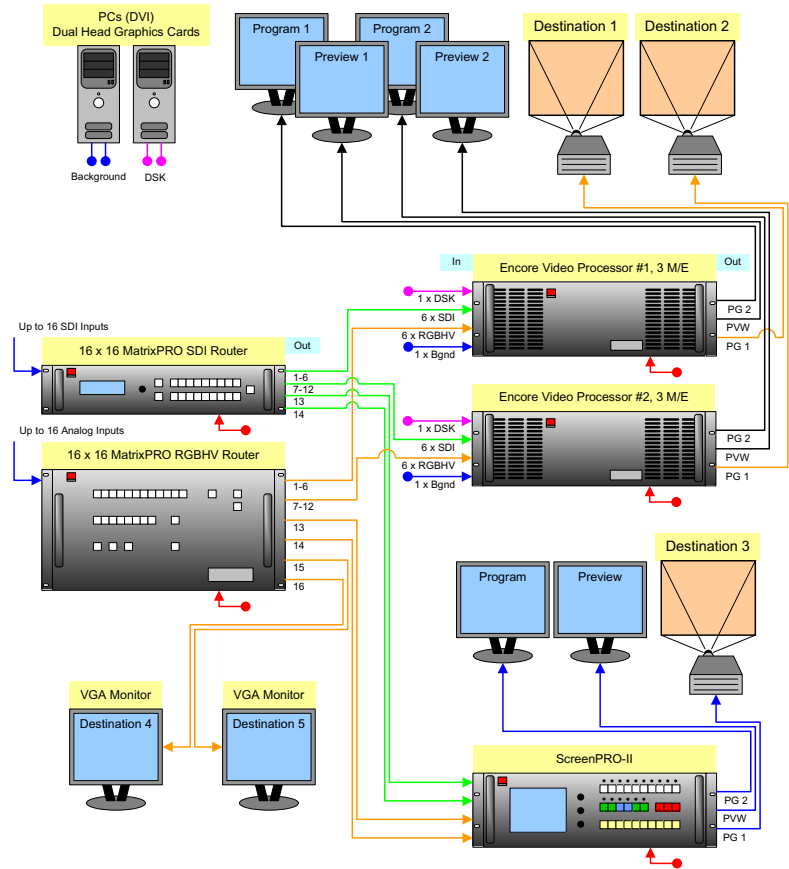
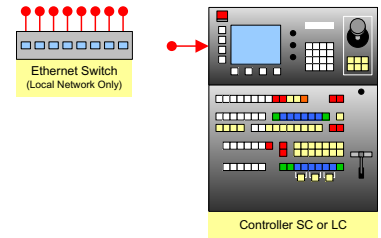

### Sample System — Wide Screen Configuration

- Non-stack system, up to 6 layers
- 3 x 3 M/E Video Processors
- 1 x SDI Router
- 1 x RGBHV Router
- 4 destinations:

- 1) 3 Projector wide screen
- 2, 3) Aux Monitors
- 4) ImagePRO Aux

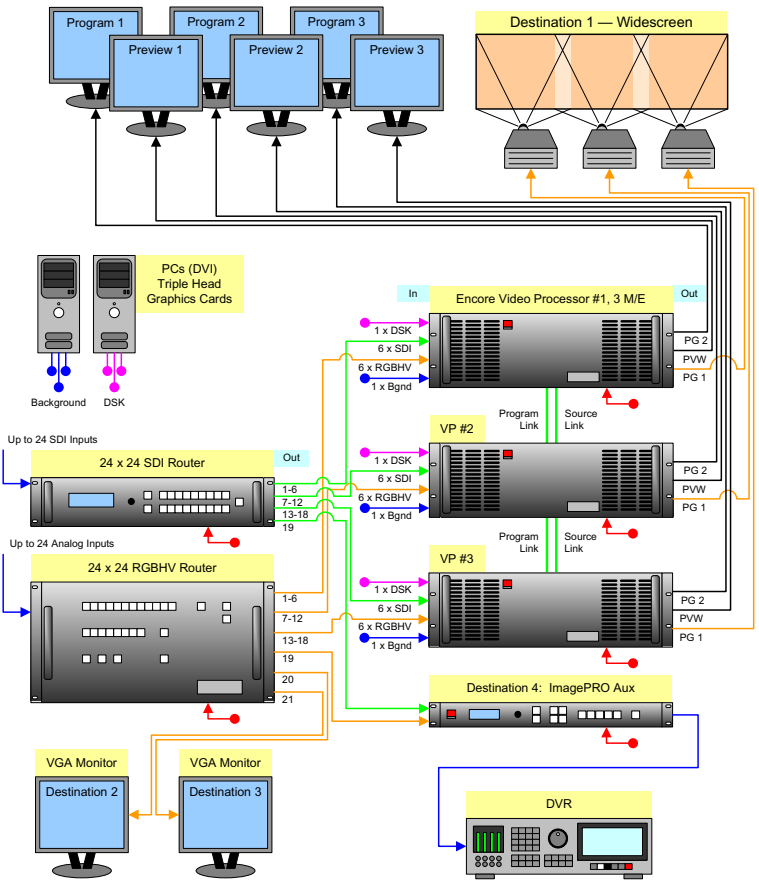
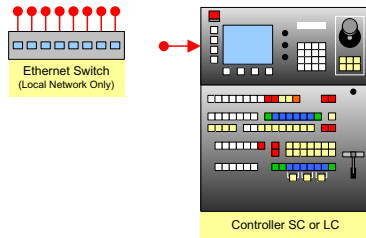

### Sample System — Single Screen “Stack” Configuration

- Stack system, up to 12 layers
- Controller LC only
- 2 x 3 M/E Video Processors
- 1 x SDI Router
- 1 x RGBHV Router
- 1 destination:

- 1) Projector

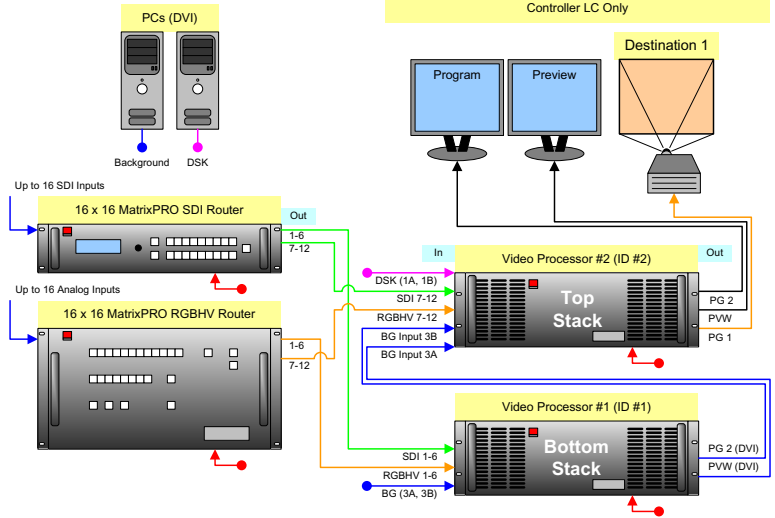
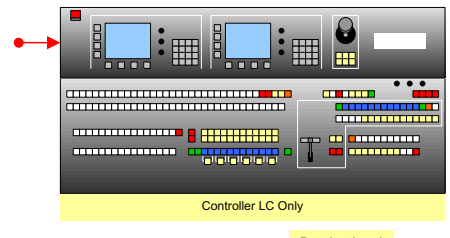

### Breakout Cables for Analog Inputs

Breakout Cable Wire Color	Comp Video	S-Video (Y/C)	YUV (YPbPr)	RGB Sync on Green	RGB Comp Sync	RGB Separate H V
R	✓	✓ (Chrom)	✓ (Pr)	✓	✓	✓
G	✓	✓ (Lum)	✓ (Lum)	✓	✓	✓
B			✓ (Pb)	✓	✓	✓
H Sync					✓	✓
V Sync						✓

### Encore Presentation System User's Guide

For complete details on all installation, setup, configuration and operations procedures, please refer to the Encore Presentation System User's Guide.

P/N 26-0313003-00, Rev A